



MIC2007/2017

Adjustable Current Limit Power Distribution Switch

General Description

The MIC2007 and MIC2017 are current limiting, high-side power switches, designed for general purpose power distribution and control in PCs, PDAs, printers and other self-powered systems.

The MIC2007 and MIC2017's primary functions are current limiting and power switching. They are thermally protected and will shutdown should their internal temperature reach unsafe levels. This protects both the device and the load under high current or fault conditions.

Features include: user adjustable output slew rate limiting, automatic load discharge and under voltage detection. Both devices offer user programmable current limiting thereby providing designers a continuous spectrum of current limits from 200mA to 2 Amps.

The MIC2017 offers a unique new feature: Kickstart™, which allows momentary high current surges to pass unrestricted without sacrificing overall system safety.

The MIC2007 and MIC2017 are excellent choices for USB and IEEE 1394 (FireWire) applications or for any system where current limiting and power control are desired.

The MIC2007 and MIC2017 are offered in space saving 6-pin SOT-23 and 2mm x 2mm MLF™ packages.

Features

- 70mΩ typical on-resistance
- 2.5V – 5.5V operating range
- User adjustable current limit: 0.2A – 2.0A
- Kickstart™
- User adjustable output slew rate control
- Automatic load discharge
- Thermal protection
- Under voltage lock-out
- Low quiescent current

Applications

- USB / IEEE 1394 power distribution
- Desktop and laptop PCs
- Set top boxes
- Game consoles
- PDAs
- Printers
- Docking stations
- Chargers

Typical Application

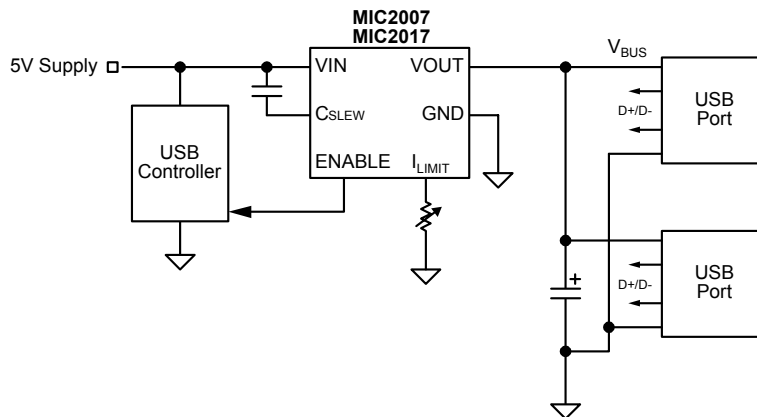

Figure 1. Typical Application Circuit

Kickstart is a trademark of Micrel, Inc
MLF and MicroLeadFrame are trademarks of Amkor Technology, Inc.

Micrel Inc. • 2180 Fortune Drive • San Jose, CA 95131 • USA • tel +1 (408) 944-0800 • fax + 1 (408) 474-1000 • <http://www.micrel.com>

MIC2000 Family Members

Part Number		I Limit	Pin Function					Load Discharge
Normal Limiting	Kickstart		I Adj.	Enable	C _{SLEW}	FAULT/	DLM*	
2003	2013	Fixed	--	--	--	--	--	--
2004	2014		--	▲	--	--	--	▲
2005	2015		--	▲	▲	▲	--	--
2006	2016		--	▲	▲	--	▲	--
2007	2017	Adj.	▲	▲	▲	--	--	▲
2008	2018		▲	▲	▲	--	--	--
2009	2019		▲	▲	--	▲	--	--

* Dynamic Load Management Adj = Adjustable current limit Fixed = Factory programmed current limit

Ordering Information

Part Number	Marking ⁽¹⁾	Current Limit	Kickstart	Pb-Free	Package
MIC2007YM6	<u>F</u> HAA	0.2A – 2.0A	No	Yes	SOT-23-6
MIC2007YML ⁽²⁾	<u>H</u> AA				2mm X 2mm MLF
MIC2017YM6	<u>F</u> QAA		Yes		SOT-23-6
MIC2017YML ⁽²⁾	<u>Q</u> AA				2mm X 2mm MLF

Notes:

- Under-bar symbol () may not be to scale.
- Consult Factory for availability

Pin Configuration

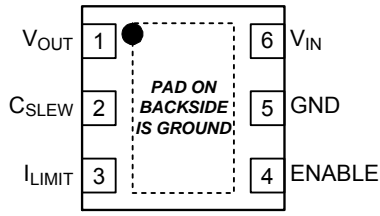

6-Pin 2mm X 2mm MLF (ML)
Top View

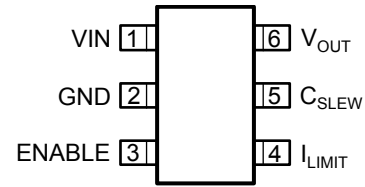

SOT 23-6 (M6)
Top View

Pin Description

Pin Number SOT-23	Pin Number MLF	Pin Name	Type	Description
1	6	VIN	Input	Supply input. This pin provides power to both the output switch and the MIC2007/2017's internal control circuitry.
2	5	GND	--	Ground.
3	4	ENABLE	Input	Output enable pin. A logic HIGH activates the output switch, applying power to the load attached to V _{OUT} .
4	3	I _{LIMIT}	Input	Sets the current limit threshold via a resistor connected between I _{LIMIT} and GND. $I_{LIMIT} = \text{Current Limiting Factor (CLF)} / R_{SET}$.
5	2	CSLEW	Input	Slew rate control. Adding a small value capacitor between this pin and VIN slows turn-ON of the power FET.
6	1	VOU	Output	Switch output. The load being driven by MIC2007/2017 is connected to this pin.

Absolute Maximum Ratings⁽¹⁾

All pins-0.3 to 6V
 Power Dissipation..... Internally Limited
 Continuous Output Current..... 2.25A
 Maximum Junction Temperature..... 150°C
 Storage Temperature-65°C to 150°C

Operating Ratings⁽²⁾

Supply Voltage..... 2.5V to 5.5V
 Continuous Output Current Range 0 to 2.1A
 Ambient Temperature Range-40°C to 85°C
 Package Thermal Resistance (θ_{JA})
 SOT-23-6230°C/W
 MLF 2x2 mm.....90°C/W
 MLF 2x2 mm θ_{JC} ⁽⁵⁾45°C/W

Electrical Characteristics

$V_{IN} = 5V$, $T_{AMBIENT} = 25^\circ C$ unless specified otherwise. **Bold** indicates -40°C to +85°C limits.

Symbol	Parameter	Conditions	Min	Typ	Max	Units
V_{IN}	Switch Input Voltage		2.5		5.5	V
I_{IN}	Internal Supply Current	Switch = OFF, ENABLE = 0V		1	5	μA
I_{IN}	Internal Supply Current	Switch = ON, $I_{OUT} = 0$ ENABLE = 1.5V		80	330	μA
I_{LEAK}	Output Leakage Current	$V_{IN} = 5V$, $V_{OUT} = 0V$, ENABLE = 0		1.2	10	μA
$R_{DS(ON)}$	Power Switch Resistance	$V_{IN} = 5V$, $I_{OUT} = 100mA$		70	100	m Ω
					125	m Ω
R_{DSCHG}	Load Discharge Resistance	$V_{IN} = 5V$, $I_{SINK} = 5mA$	70	126	200	Ω
CLF	Current Limit: Factor $R_{SET} (\Omega) = \frac{CLF (V)}{I_{OUT} (A)}$	$I_{OUT} = 2.0A$, $V_{OUT} = 0.8V_{IN}$	210	250	286	V
		$I_{OUT} = 1.0A$, $V_{OUT} = 0.8V_{IN}$	190	243	293	V
		$I_{OUT} = 0.5A$, $V_{OUT} = 0.8V_{IN}$	168	235	298	V
		$I_{OUT} = 0.2A$, $V_{OUT} = 0.8V_{IN}$	144	225	299	V
I_{LIMIT_2nd}	Secondary current limit (Kickstart)	MIC2017, $V_{IN} = 2.5V$	2.2	4	6	A
UVLO _{THRESHOLD}	Under Voltage Lock Out threshold	V_{IN} rising	2.0	2.25	2.5	V
		V_{IN} falling	1.9	2.15	2.4	V
V_{EN}	ENABLE Input Voltage	$V_{IL(max.)}$			0.5	V
		$V_{IH(min.)}$	1.5			
I_{EN}	ENABLE Input Current	$V_{EN} = 0V$ to 5.0V		1	5	μA
OT _{THRESHOLD}	Over-temperature Threshold	T_J increasing		145		$^\circ C$
		T_J decreasing		135		

AC Characteristics

Symbol	Parameter	Condition	Min	Typ	Max	Units
t_{RISE}	Output turn-ON rise time	$R_L = 10\Omega$, $C_{LOAD} = 1\mu F$, $V_{OUT} = 10\%$ to 90%	500	1000	1500	μs
t_{D_LIMIT}	Delay before current limiting	MIC2017	77	128	192	ms
t_{RESET}	Delay before resetting Kickstart current limit delay, t_{D_LIMIT}	Out of current limit following a current limit event. MIC2017	77	128	192	ms
t_{ON_DLY}	Output Turn-on Delay	$R_L = 43\Omega$, $C_L = 120\mu F$, $C_{SLEW} \leq 10pF$, $V_{EN} = 50\%$ to $V_{OUT} = 10\%$		1000	1500	μs
t_{OFF_DLY}	Output Turn-off Delay	$R_L = 43\Omega$, $C_L = 120\mu F$, $C_{SLEW} \leq 10pF$, $V_{EN} = 50\%$ to $V_{OUT} = 90\%$			700	μs

ESD

Symbol	Parameter	Condition	Min	Typ	Max	Units
V_{ESD_HB}	Electrostatic Discharge Voltage: Human Body Model	V_{OUT} and GND	± 4			kV
		All other pins	± 2			kV
V_{ESD_MCHN}	Electrostatic Discharge Voltage: Machine Model	All pins Machine Model	± 200			V

Notes:

1. Exceeding the absolute maximum rating may damage the device.
2. The device is not guaranteed to function outside its operating rating.
3. Devices are ESD sensitive. Handling precautions recommended. Human body model: 1.5k in series with 100pF.
4. Specification for packaged product only.
5. Requires proper thermal mounting to achieve this performance.

Timing Diagrams

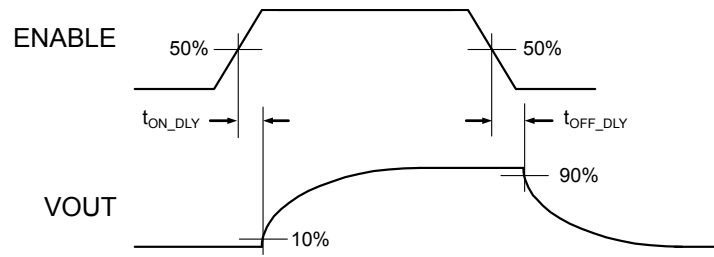

Switching Delay Times

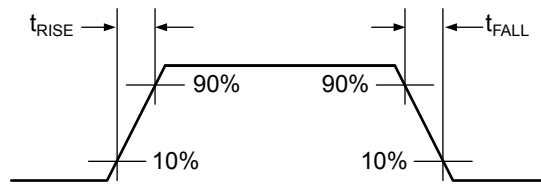

Rise and Fall Times

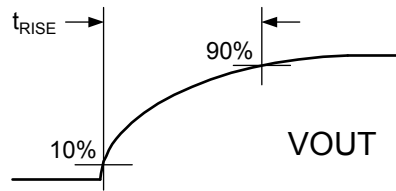

Output Rise Time

Typical Characteristics

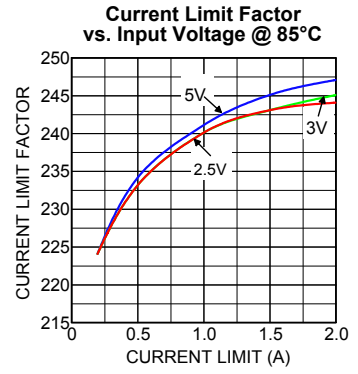
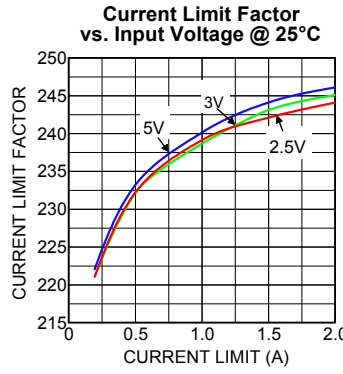
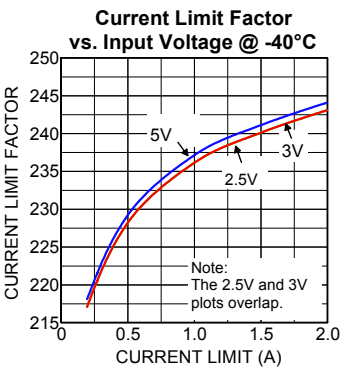
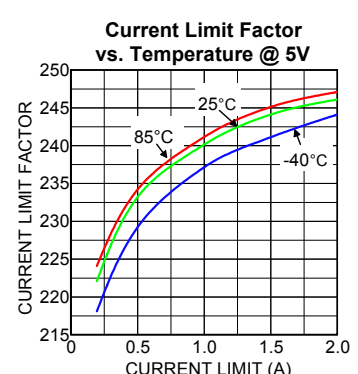
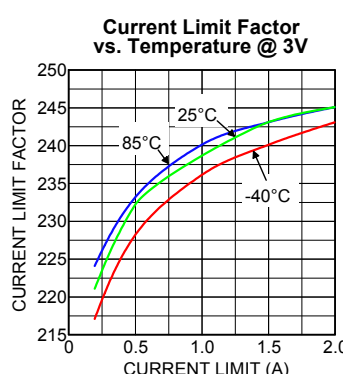
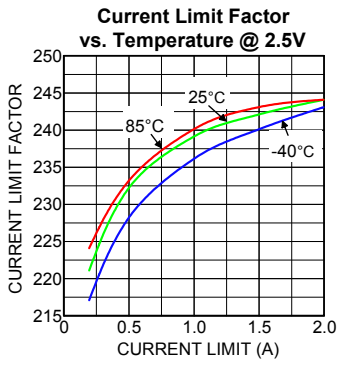
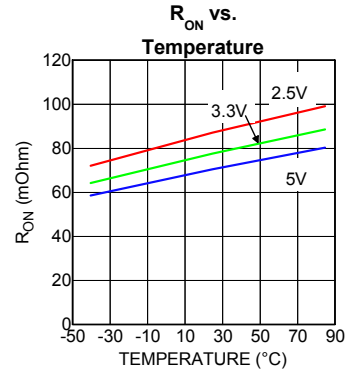
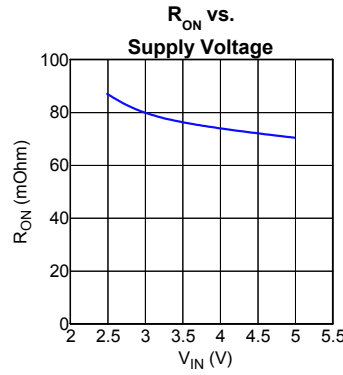
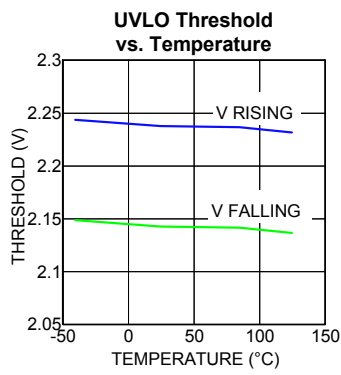
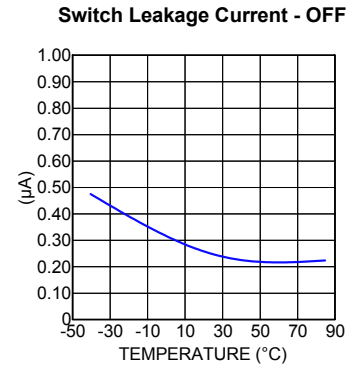
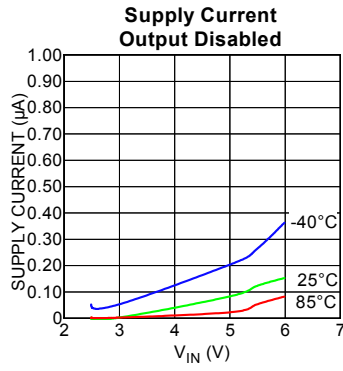
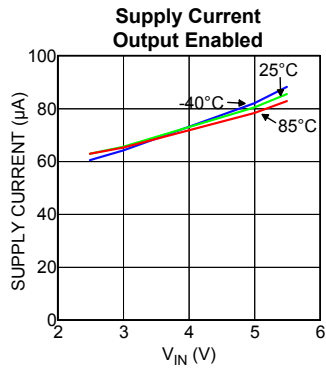

Functional Characteristics

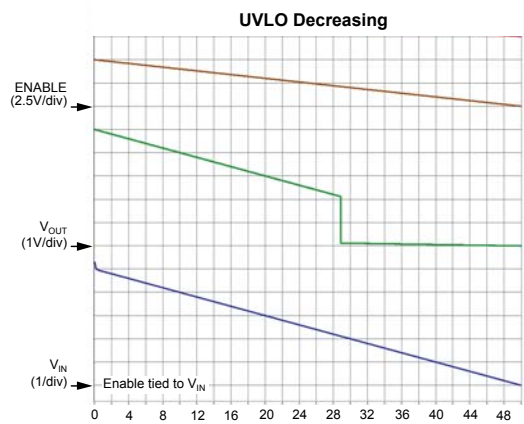
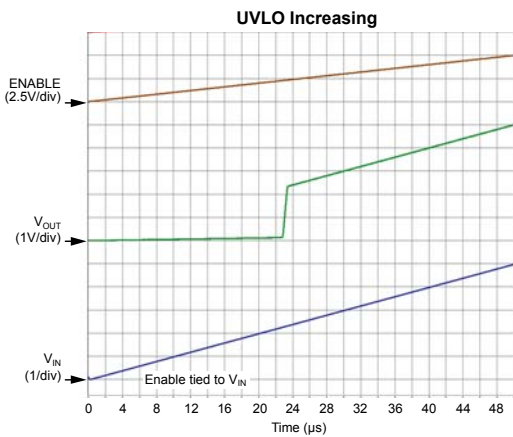
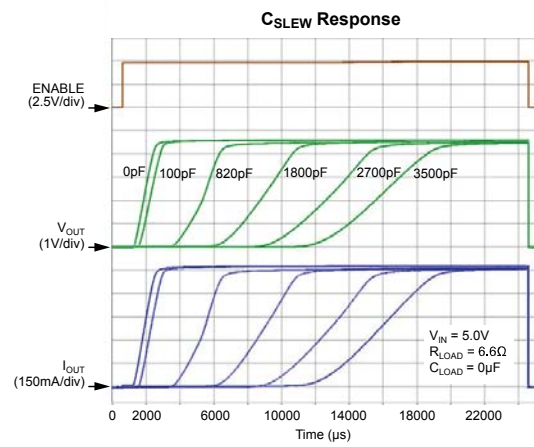
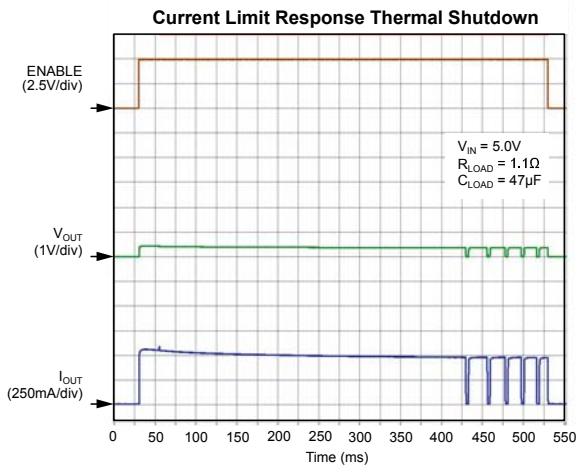
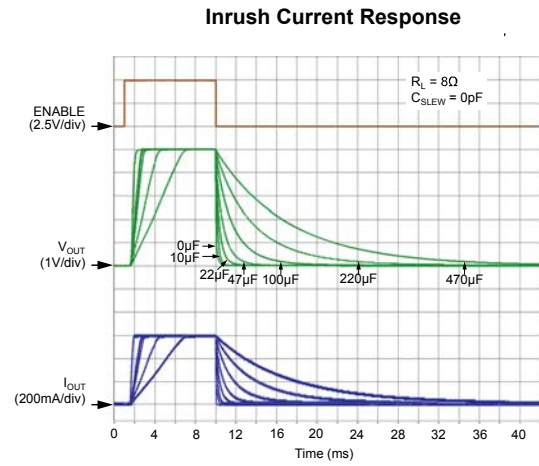
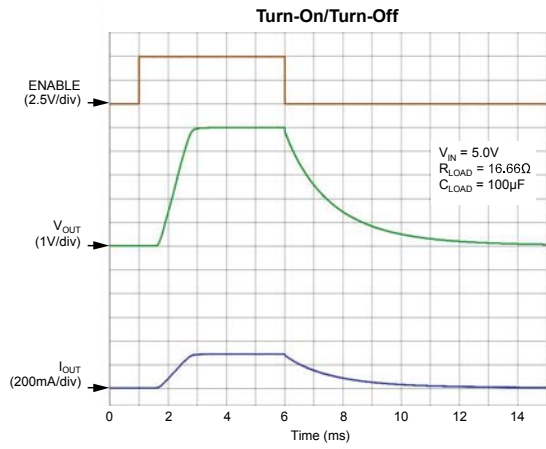

**Kickstart Response
Normal Load with Temporary High Load**

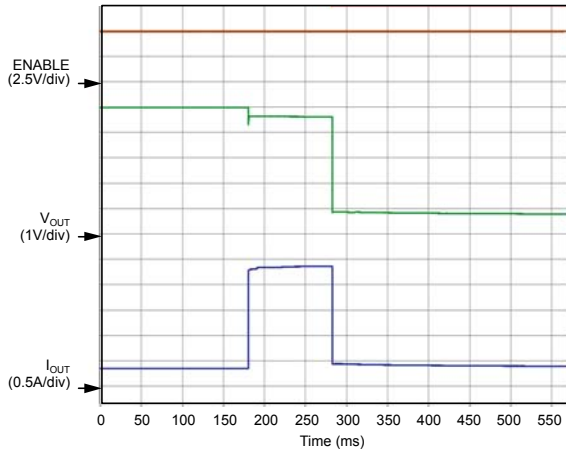

**Kickstart Response
No Load to Short Circuit**

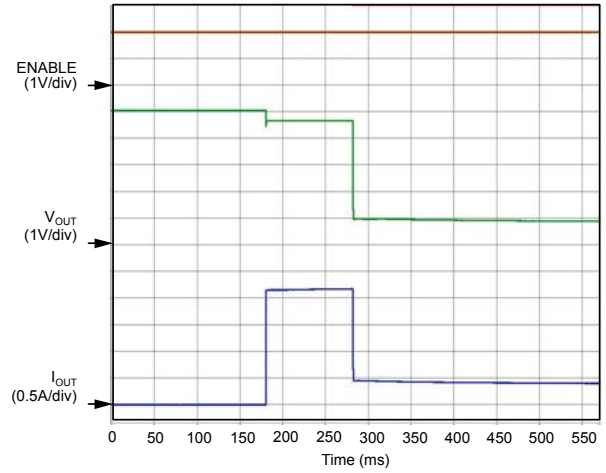

**Kickstart Response
Normal Load with Temporary Short Circuit**

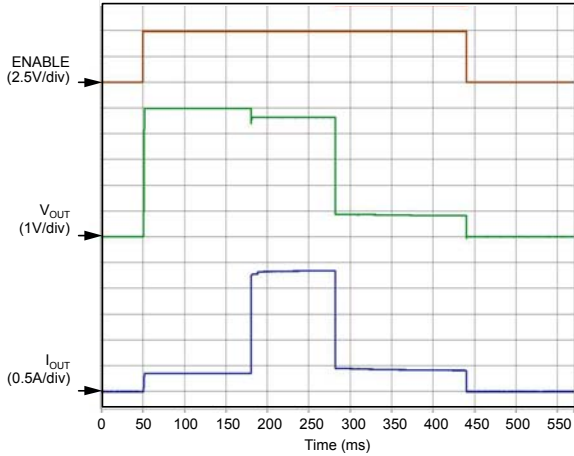

**Kickstart Response
Device Enabled into a Short Circuit**

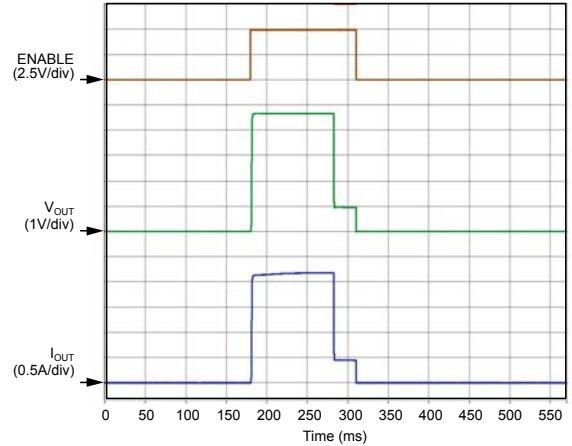

Functional Diagram

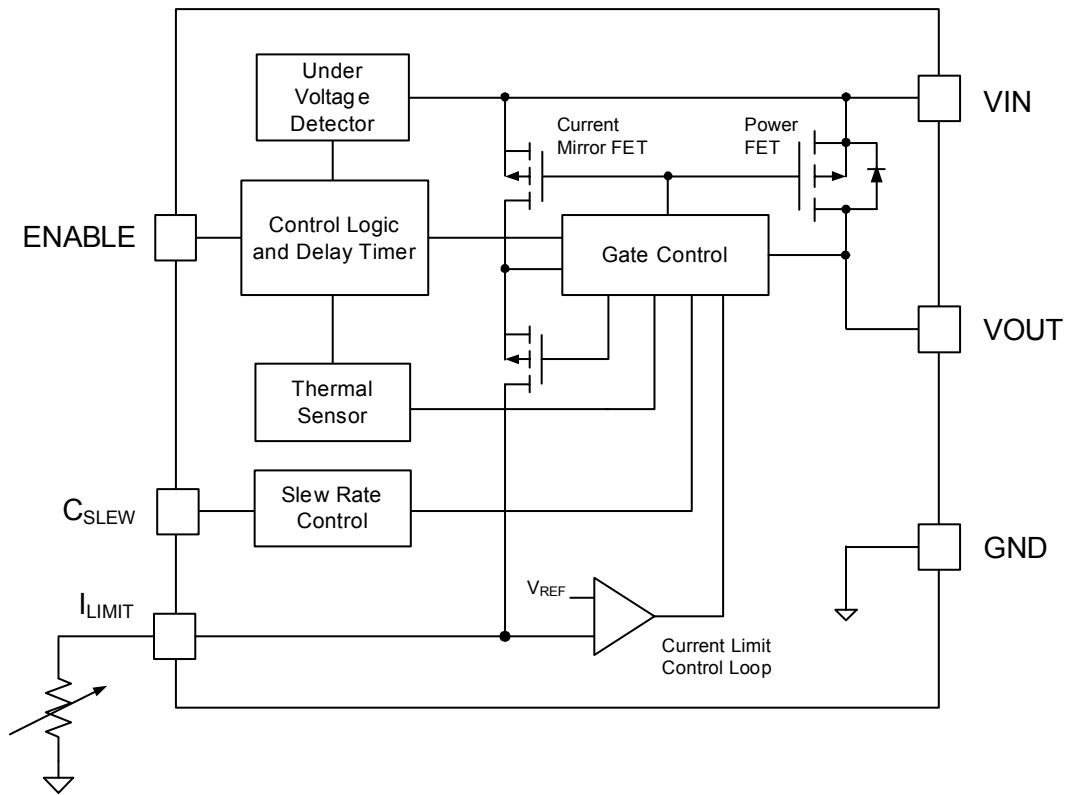

Figure 2. MIC2007/2017 Block Diagram

Functional Description

Input and Output

V_{IN} is both the power supply connection for the internal circuitry driving the switch and the input (Source connection) of the power MOSFET switch. V_{OUT} is the Drain connection of the power MOSFET and supplies power to the load. In a typical circuit, current flows from V_{IN} to V_{OUT} toward the load. Since the switch is bi-directional when enabled, if V_{OUT} is greater than V_{IN} , current will flow from V_{OUT} to V_{IN} .

When the switch is disabled, current will not flow to the load, except for a small unavoidable leakage current of a few microamps. However, should V_{OUT} exceed V_{IN} by more than a diode drop ($\sim 0.6V$), while the switch is disabled, current will flow from output to input via the power MOSFET's body diode. While this effect can be used to advantage when large bypass capacitors are placed on MIC2007/2017's's output, it can not be relied upon to fully or reliably discharge the load capacitance, because discharging depends upon the characteristics of the circuitry at V_{IN} .

To ensure proper discharge of any output capacitance, MIC2007/2017 is equipped with a discharge FET which is ON any time the device is not Enabled.

Current Sensing and Limiting

The MIC2007/2017 protects the system power supply and load from damage by continuously monitoring current through the on-chip power MOSFET. Load current is monitored, by means of a current mirror, in parallel with the power MOSFET switch. Current limiting is invoked when the load exceeds an externally set over-current threshold. When current limiting is activated the output current is constrained to the limit value, and remains at this level until either the load/fault is removed, the load's current requirement drops below the limiting value, or the MIC2007/2017 goes into thermal shutdown.

Kickstart (MIC2017 only)

The MIC2017 is designed to allow momentary current surges (Kickstart) before the onset of current limiting, which permits dynamic loads, such as small disk drives or portable printers to draw the energy needed to overcome inertial loads without sacrificing system safety. In this respect, the MIC2017 differs markedly from MIC2007 and its peers, which immediately limit load current, potentially starving the motor and causing the appliance to stall or stutter.

During this delay period, typically 128 ms, a secondary current limit is in effect. If the load demands a current in excess of the secondary limit, the MIC2017 acts immediately to restrict output current to the secondary

limit for the duration of the Kickstart period. After this time, the MIC2017 reverts to its normal current limit. An example of Kickstart operation is shown below.

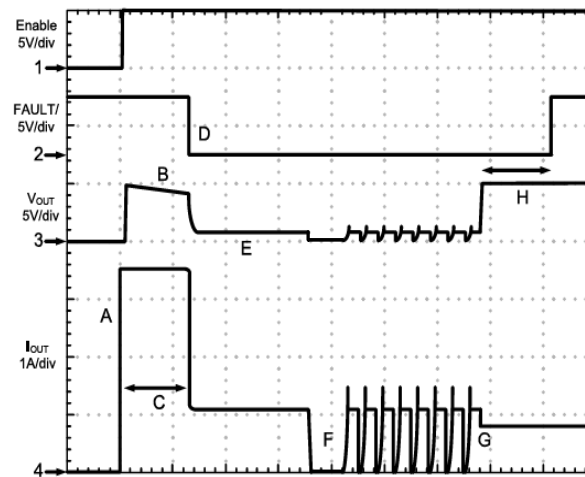

Figure 3. Kickstart Operation

Picture Key:

- A) MIC2017 is enabled into an excessive load (slew rate limiting not visible at this time scale) The initial current surge is limited by either the overall circuit resistance and power supply compliance, or the secondary current limit, whichever is less.
- B) R_{ON} of the power FET increases due to internal heating (effect exaggerated for emphasis).
- C) Kickstart period.
- D) Current limiting initiated. FAULT/ goes LOW. (Note: MIC2007/2017 does not provide a FAULT/ output.)
- E) V_{OUT} is non-zero (load is heavy, but not a dead short where $V_{OUT} = 0$). Limiting response will be the same for dead shorts).
- F) Thermal shutdown followed by thermal cycling.
- G) Excessive load released, normal load remains. MIC2017 drops out of current limiting.
- H) FAULT/ delay period followed by FAULT/ going HIGH. (Note: MIC2007/2017 does not provide a FAULT/ output.)

Under Voltage Lock Out

Under voltage lock-out insures no anomalous operation occurs before the device's minimum input voltage of 2.5V had been achieved. Prior to reaching this voltage, the output switch (power MOSFET) is OFF and no circuit functions, such as ENABLE, are considered to be valid or operative.

Enable

ENABLE is a HIGH true control signal, which activates the main MOSFET switch. ENABLE will operate with logic running from supply voltages as low as 1.8V, once V_{IN} has exceeded the UVLO threshold. ENABLE can be wire-OR'd with other MIC2007/2017s or similar devices without damage to the device.

ENABLE may be driven higher than V_{IN} , but no higher than 5.5V.

Slew Rate Control

Large capacitive loads can create significant current surges when charged through a high-side switch such as the MIC2007/2017. For this reason, the MIC2007/2017 provides built-in slew rate control to limit the initial inrush currents upon enabling the power MOSFET switch.

Slew rate control is active upon powering up, and upon re-enabling the load. At shutdown, the discharge slew rate is controlled by the external load and output capacitor.

On MIC2007/2017 slew rate is adjustable and can be

further reduced by adding an external capacitance between VIN and the CSLEW pins.

Thermal Shutdown

Thermal shutdown is employed to protect the MIC2007/2017 from damage should the die temperature exceed safe operating levels. Thermal shutdown shuts off the output MOSFET if the die temperature reaches 145°C.

The MIC2007/2017 will automatically resume operation when the die temperature cools down to 135°C. If resumed operation results in reheating of the die, then another shutdown cycle will occur and the MIC2007/2017 will continue cycling between ON and OFF states until the offending load has been removed.

Depending upon PCB layout, package type, ambient temperature, etc., hundreds of milliseconds may elapse from the incidence of a fault to the output MOSFET being shut off. This delay is due to thermal time constants within the system itself. In no event will the device be damaged due to thermal overload because die temperature is monitored continuously by on-chip circuitry.

Application Information

Setting I_{LIMIT}

The MIC2007/2017's current limit is user programmable and controlled by a resistor connected between the I_{LIMIT} pin and Ground. The value of this resistor is determined by the following equation:

$$I_{LIMIT} = \frac{\text{Current Limit Factor (CLF)}}{R_{SET}}$$

or

$$R_{SET} (\Omega) = \frac{\text{Current Limit Factor (V)}}{I_{LIMIT} (A)}$$

Example: Set $I_{LIMIT} = 1.25A$

Looking in the Electrical specifications we will find CLF at $I_{LIMIT} = 1A$. For the sake of this example, we will say the typical value of CLF at an I_{OUT} of 1A is 235V. Applying the equation above:

$$R_{SET} (\Omega) = \frac{235 V}{1.25 A}$$

$$R_{SET} = 188 \Omega$$

Designers should be aware that variations in the measured I_{LIMIT} for a given R_{SET} resistor, will occur because of small differences between individual ICs (inherent in silicon processing) resulting in a spread of I_{LIMIT} values. In the example above we used the typical value of CLF to calculate R_{SET} . We can determine I_{LIMIT} 's spread by using the minimum and maximum values of CLF and the calculated value of R_{SET} .

$$R_{SET} = 187 \Omega$$

(the closest standard 1% value)

$$I_{LIMIT_MIN} = \frac{210V}{187\Omega} = 1.12A$$

$$I_{LIMIT_MAX} = \frac{260V}{187\Omega} = 1.39A$$

Giving us a maximum I_{LIMIT} variation over temperature of:

I_{LIMIT_MIN}	I_{LIMIT_TYP}	I_{LIMIT_MAX}
1.12A	1.25A	1.39A

or

$$1.25A \pm 11\%$$

I_{LIMIT} vs. I_{OUT} measured

The MIC2007/2017's current limiting circuitry is designed to act as a constant current source to the load. As the load tries to pull more than the allotted current, V_{OUT} drops and the input to output voltage differential increases. When $V_{IN} - V_{OUT}$ exceeds 1V, I_{OUT} drops below I_{LIMIT} to reduce the drain of fault current on the system's power supply and to limit internal heating of the MIC2007/2017.

When measuring I_{OUT} it is important to bear this voltage dependence in mind. Otherwise, the measurement data may appear to indicate a problem when none really exists. This voltage dependence is illustrated in Figures 4 and 5.

In Figure 4, output current is measured as V_{OUT} is pulled below V_{IN} , with the test terminating when V_{OUT} is 1V below V_{IN} . Observe that once I_{LIMIT} is reached I_{OUT} remains constant throughout the remainder of the test. In Figure 5, this test is repeated but with $V_{IN} - V_{OUT}$ exceeding 1V.

When $V_{IN} - V_{OUT} > 1V$, the MIC2007/2017's current limiting circuitry responds by decreasing I_{OUT} , as can be seen in Figure 5. In this demonstration, V_{OUT} is being controlled and I_{OUT} is the measured quantity. In real life applications, V_{OUT} is determined in accordance with Ohm's law by the load and the limiting current.

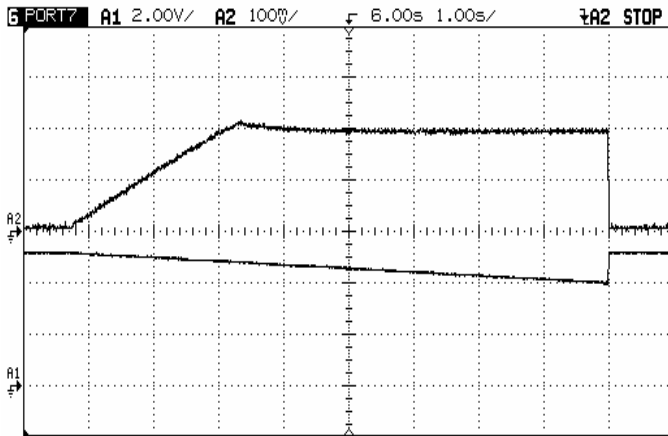

2009B SOT 502 #1 - Vout ramp 5V to 4V (5V)
 R_{adj}=249ohms, R_{fault}=499ohms
 A1: Vout (2V/div)
 A2: Iout (500mA/div)

Figure 4. I_{OUT} in Current Limiting for V_{IN} - V_{OUT} ≤ 1V

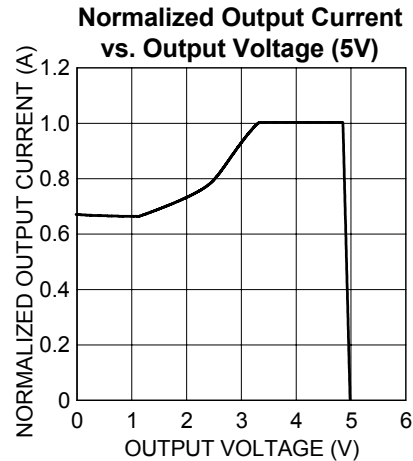
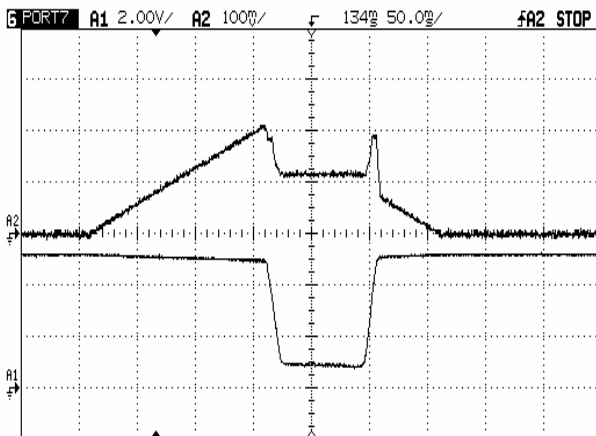

Figure 6.



2009B SOT 502 #1 - Current ramp (5V)
 R_{adj}=249ohms, R_{fault}=499ohms
 A1: Vout (2V/div)
 A2: Iout (500mA/div)

Figure 5. I_{OUT} in Current Limiting for V_{IN} - V_{OUT} > 1V

This folding back of I_{LIMIT} can be generalized by plotting I_{LIMIT} as a function of V_{OUT}, as shown below. The slope of V_{OUT} between I_{OUT} = 0 and I_{OUT} = I_{LIMIT} (where I_{LIMIT} = 1) is determined by R_{ON} of MIC2007/2017 and I_{LIMIT}.

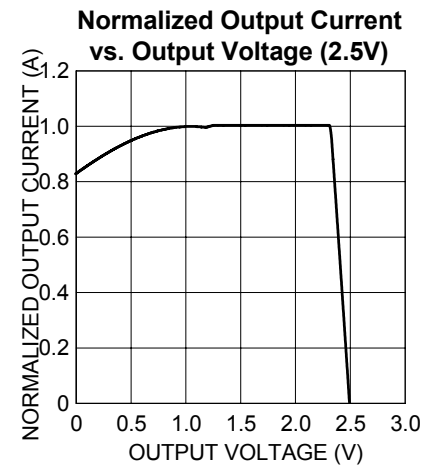

Figure 7.

C_{SLEW}

The CSLEW input is provided to increase control of the output voltage ramp at turn-on. This input allows designers the option of decreasing the output's slew rate (slowing the voltage rise) by adding an external capacitance between the pin, CSLEW, and VIN. This capacitance slows the rate at which the pass FET gate voltage increases and thus, slows both the response to an Enable command as well as V_{OUT}'s ascent to its final value.

Figure 8 illustrates effect of C_{SLEW} on turn-ON delay and output rise time.

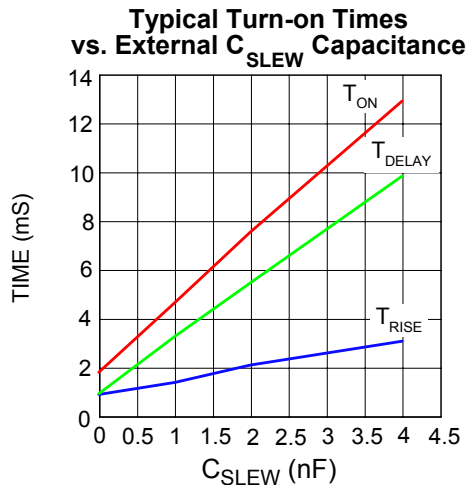

Figure 8.

C_{SLEW}'s effect on I_{LIMIT}

An unavoidable consequence of adding C_{SLEW} capacitance is a reduction in the MIC2008/2018's ability to quickly limit current transients or surges. A sufficiently large capacitance can prevent both the primary and secondary current limits from acting in time to prevent damage to the MIC2008/2018 or the system from a short circuit fault. For this reason, the upper limit on the value of C_{SLEW} is 4nF.

Kickstart (MIC2017)

Kickstart allows brief current surges to pass to the load before the onset of normal current limiting. This, in turn, permits dynamic loads to draw bursts of energy without sacrificing system safety.

Functionally, Kickstart is a forced override of the normal current limiting function provided by the MIC2017. The Kickstart period is governed by an internal timer which allows current to pass unimpeded to the load for 128ms and then normal (primary) current limiting goes into action.

During Kickstart a secondary current limiting circuit is monitoring output current to prevent damage to the MIC2017. This is because a hard short, combined with a robust power supply, can result in currents of many tens of amperes. This secondary current limit is nominally set at 4 Amps and reacts immediately and independently of the Kickstart period. Once the Kickstart timer has finished its count, the primary current limiting circuit takes over and holds I_{OUT} to its programmed limit for as long as the excessive load persists.

Once the MIC2017 drops out of current limiting the Kickstart timer initiates a lock-out period of 128ms such that no further bursts of current above the primary current limit, will be allowed until the lock-out period has expired.

Kickstart may be over-ridden by the thermal protection circuit and if sufficient internal heating occurs, Kickstart will be terminated and I_{OUT} → 0. Upon cooling, if the load is still present I_{OUT} → I_{LIMIT}, not I_{KICKSTART}.

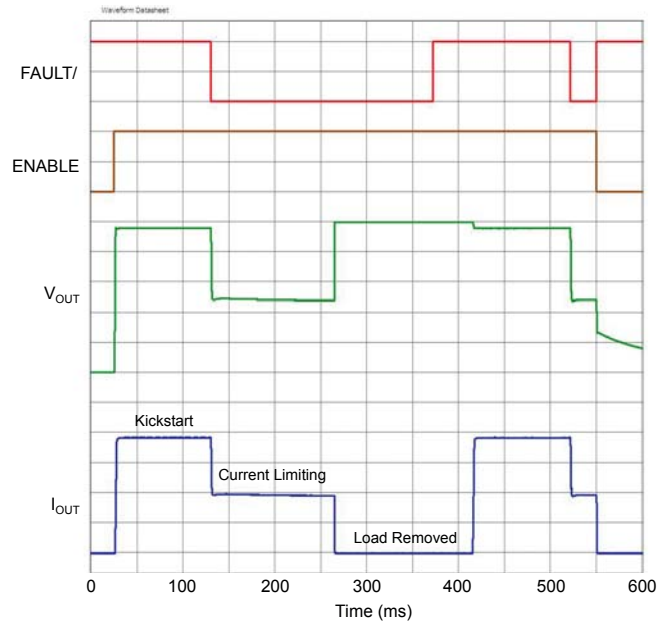

Figure 9. Kickstart Operation with Varying Load

Supply Filtering

A 0.1µF to 1µF bypass capacitor positioned close to the V_{IN} and GND pins of MIC2007/2017 is both good design practice and required for proper operation of the MIC2007/2017. This will control supply transients and ringing. Without a bypass capacitor, large current surges or an output short may cause sufficient ringing on V_{IN} (from supply lead inductance) to cause erratic operation of the MIC2007/2017's control circuitry. Good quality, low ESR capacitors, such as Panasonic's TE or ECJ series, are suggested.

When bypassing with capacitors of 10µF and up, it is good practice to place a smaller value capacitor in parallel with the larger to handle the high frequency components of any line transients. Values in the range of 0.01µF to 0.1µF are recommended. Again, good quality, low ESR capacitors should be chosen.

Power Dissipation

Power dissipation depends on several factors such as the load, PCB layout, ambient temperature, and supply voltage. Calculation of power dissipation can be accomplished by the following equation:

$$P_D = R_{DS(ON)} \times (I_{OUT})^2$$

To relate this to junction temperature, the following

equation can be used:

$$T_J = P_D \times R_{\theta(J-A)} + T_A$$

Where: T_J = junction temperature,

T_A = ambient temperature

$R_{\theta(J-A)}$ is the thermal resistance of the package

In normal operation, the MIC2007/2017's R_{on} is low enough that no significant I^2R heating occurs. Device heating is most often caused by a short circuit — or very heavy load — when a significant portion of the input supply voltage appears across the MIC2007/2017's power MOSFET. Under these conditions, the heat generated will exceed the package and PCB's ability to cool the device and thermal limiting will be invoked.

In Figure 10, die temperature is plotted against I_{OUT} assuming a constant case temperature of 85°C. The plots also assume a worst case R_{ON} of 140 mΩ at a die temperature of 135°C. Under these conditions, it is clear that an SOT-23 packaged device will be on the verge of thermal shutdown (typically 145°C die temperature) when operating at a load current of 1.25A. For this reason, it is recommend that MLF package be used for any MIC2007/2017 designs intending to supply continuous currents of 1A or more.

performance at higher current levels, or in higher temperature environments, thermal contact with the PCB and the exposed power paddle on the back side of the MLF package should be made. This significantly reduces the package's thermal resistance thereby extending the MIC2007/2017's operating range. It should be noted that this backside paddle is electrically active and is connected to the MIC2007/2017's GND pin.

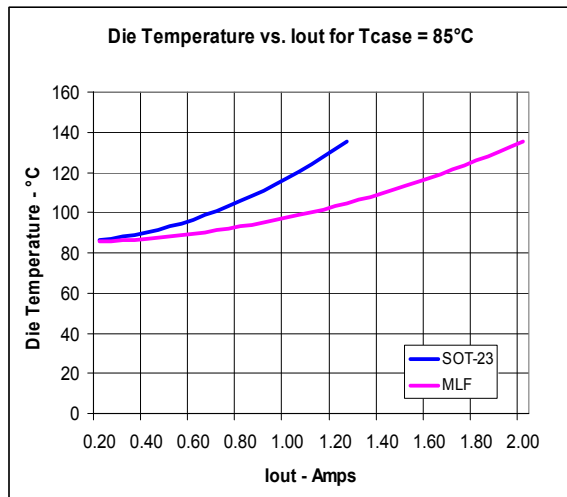

Figure 10. Die Temperature vs. Package

Figure 10 assumes no backside contact is made to the thermal pad provided on the MLF package. For optimal

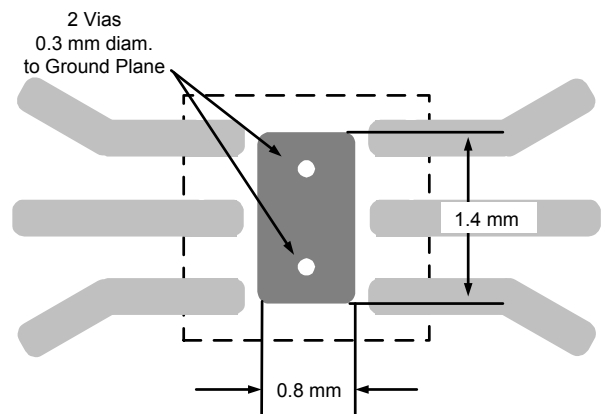
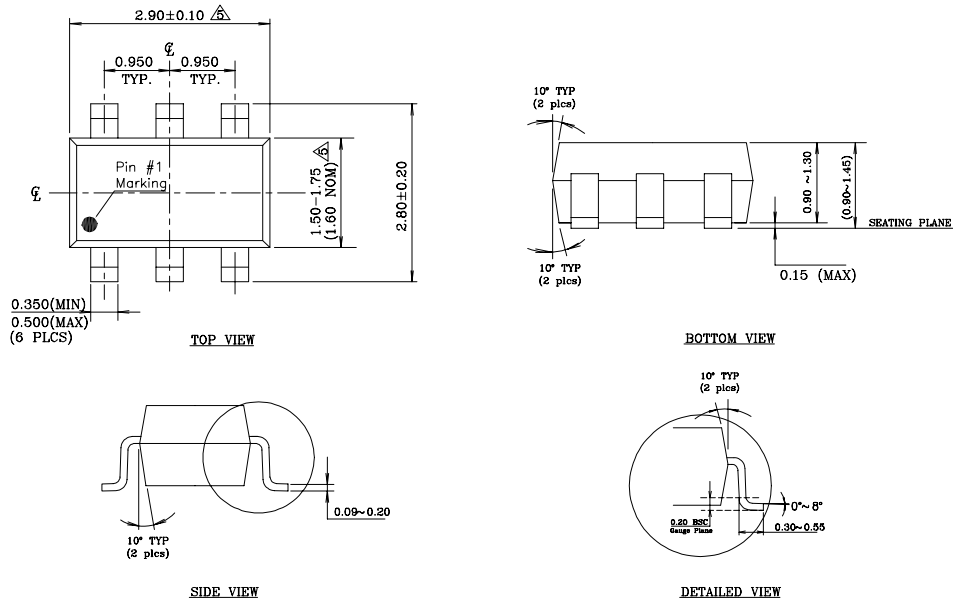
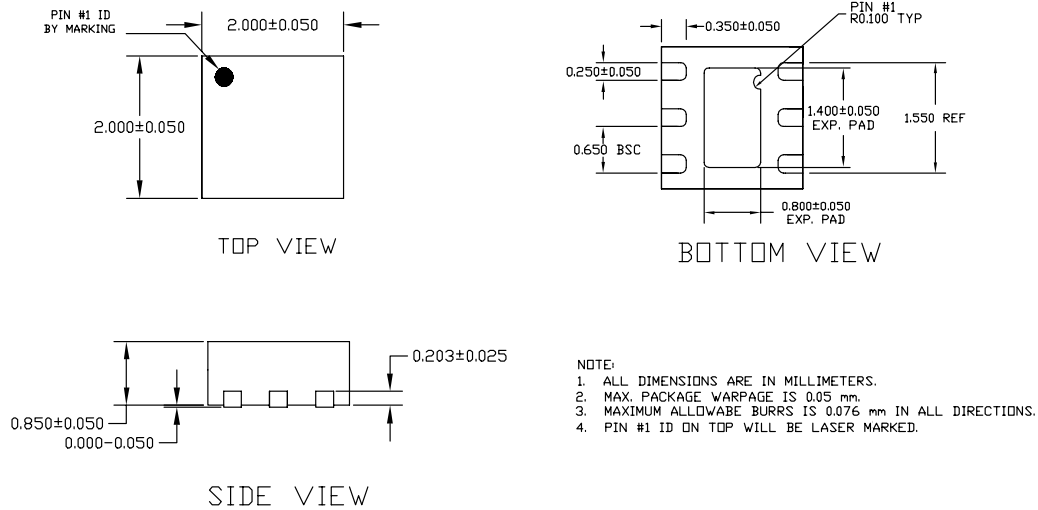

Figure 11. Pad for Thermal Mounting to PCB

Package Information



6-Pin SOT-23 (M6)



6-Pin 2mm X 2mm MLF (ML)

MICREL, INC. 2180 FORTUNE DRIVE SAN JOSE, CA 95131 USA
 TEL +1 (408) 944-0800 FAX +1 (408) 474-1000 WEB <http://www.micrel.com>

The information furnished by Micrel in this data sheet is believed to be accurate and reliable. However, no responsibility is assumed by Micrel for its use. Micrel reserves the right to change circuitry and specifications at any time without notification to the customer.

Micrel Products are not designed or authorized for use as components in life support appliances, devices or systems where malfunction of a product can reasonably be expected to result in personal injury. Life support devices or systems are devices or systems that (a) are intended for surgical implant into the body or (b) support or sustain life, and whose failure to perform can be reasonably expected to result in a significant injury to the user. A Purchaser's use or sale of Micrel Products for use in life support appliances, devices or systems is a Purchaser's own risk and Purchaser agrees to fully indemnify Micrel for any damages resulting from such use or sale.